

Navodila za montažo plisejev Cosiflor PL 11

Zahtevnost



Bolj zahtevno

Priporočeno št. oseb za montažo



Potreben čas

15-20 minut

Pripomočki

Tračni meter, baterijski izvijač,
nastavki, sveder, ročni izvijač, svinčnik.

OPOZORILO PRED MONTAŽO

- Shranite z navodili za vzdrževanje!
- Za montažo uporabljajte samo ročni izvojač in ne električnega.

OPOZORILO ZA ...

NAROČILA IZ SPLETNE TRGOVINE.

Če ste plise senčilo naročili preko naše spletne trgovine vas prosimo, da **upoštevate navodila za montažo, ki se nahajajo na spletni trgovini**. Do navodil lahko hitro dostopate s skeniranjem spodnje QR kode, če vam naprava tega ne omogoča, pa v brskalnik vpišite povezavo, ki je napisana poleg.

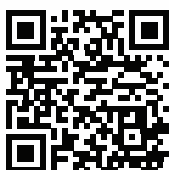

Bodite pozorni, da izberete ustrezno navodilo za montažo pliseja (za vertikalno ali strešno okno).

<https://sencila-medle.si/shop/plise>

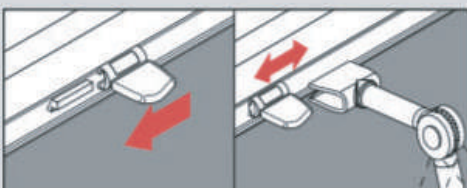
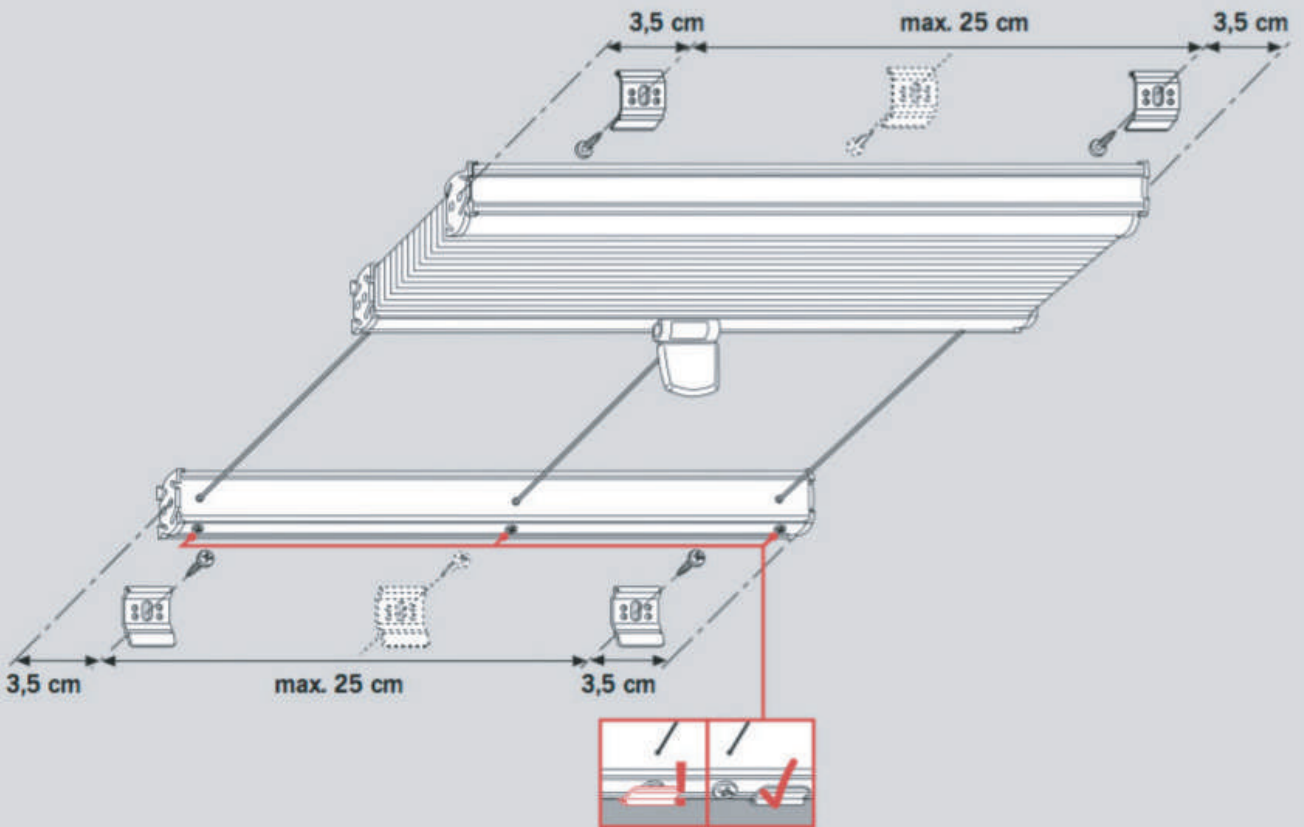

ZGORNJE FIKSIRANJE Top fixing Falzmontage

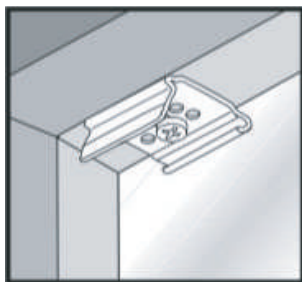

		2,2 mm \varnothing
		2,0 mm \varnothing
		1,5 mm \varnothing

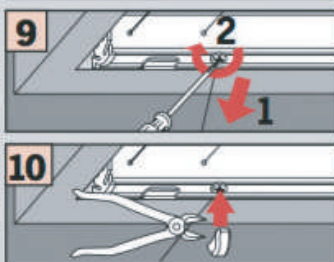
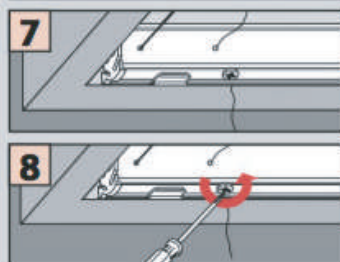
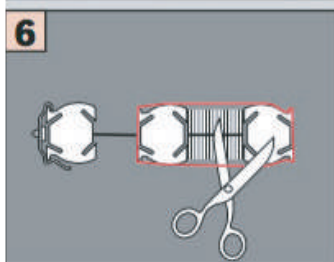
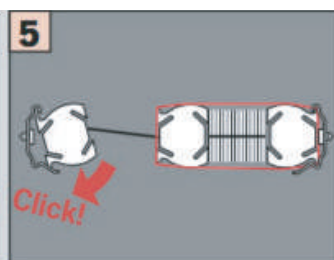
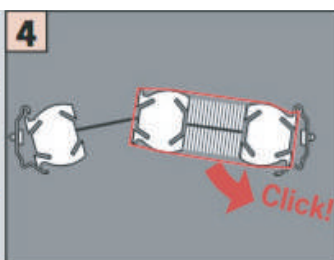
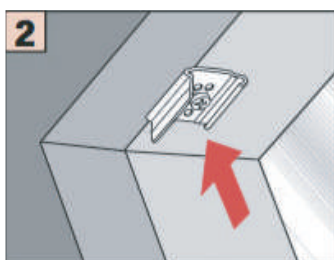
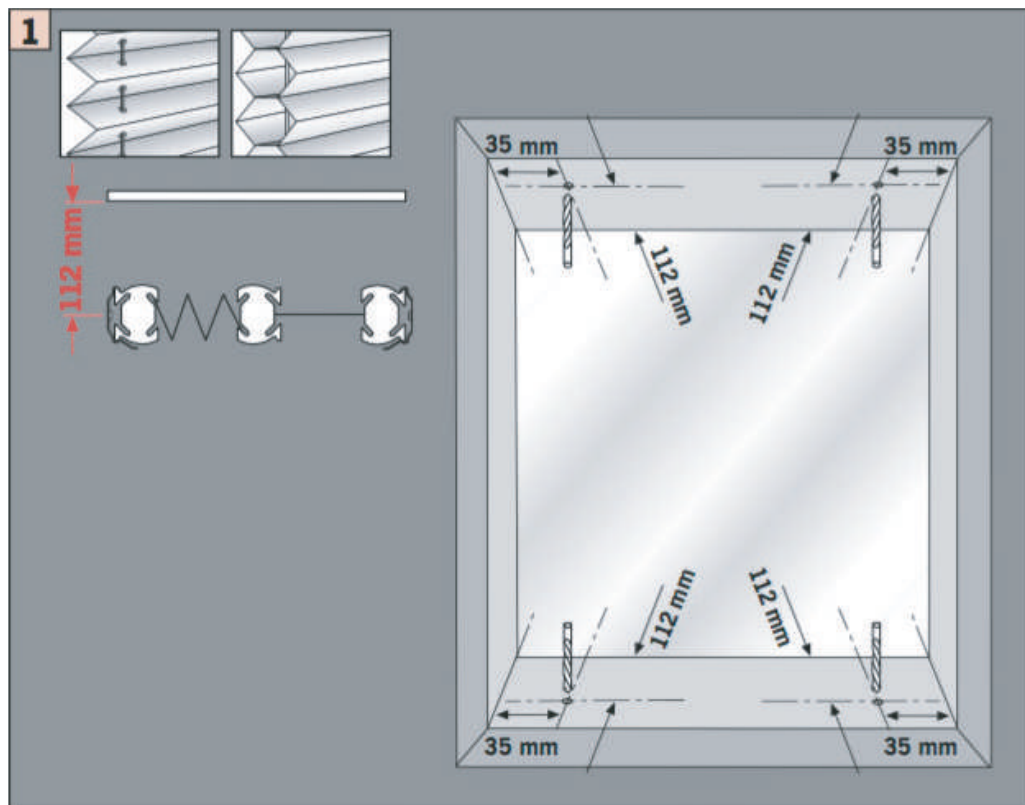

DEMONTAŽA Disassembly Demontage

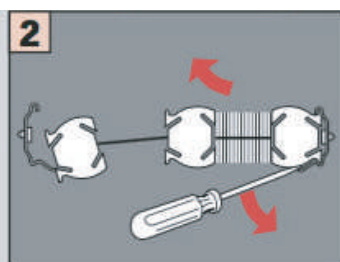
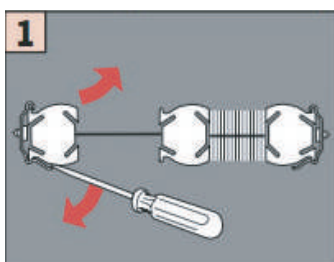

STRANSKO FIKSIRANJE Face fixing Winkelmontage

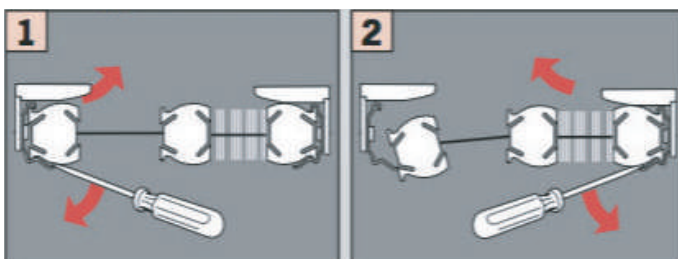
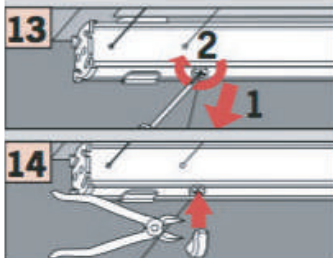
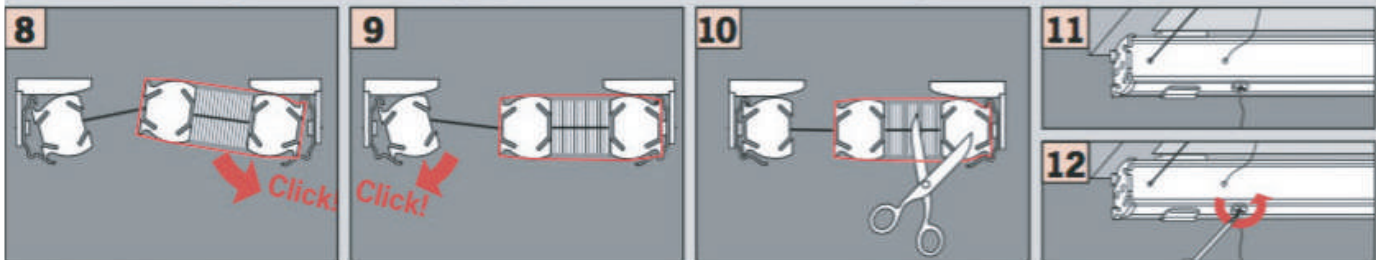
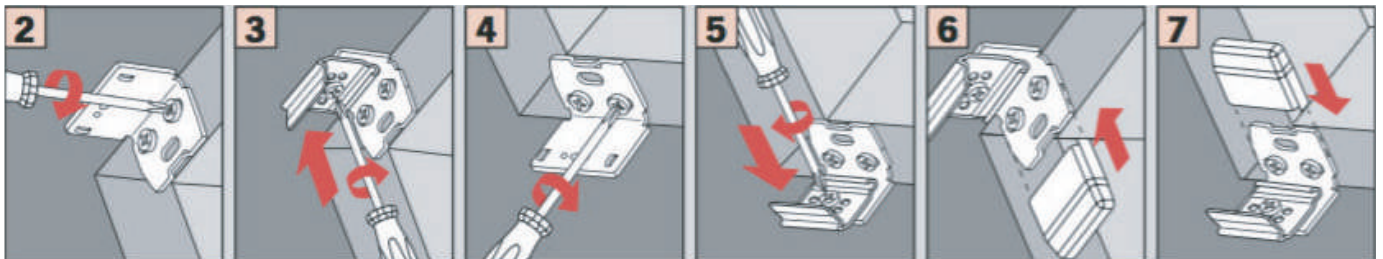
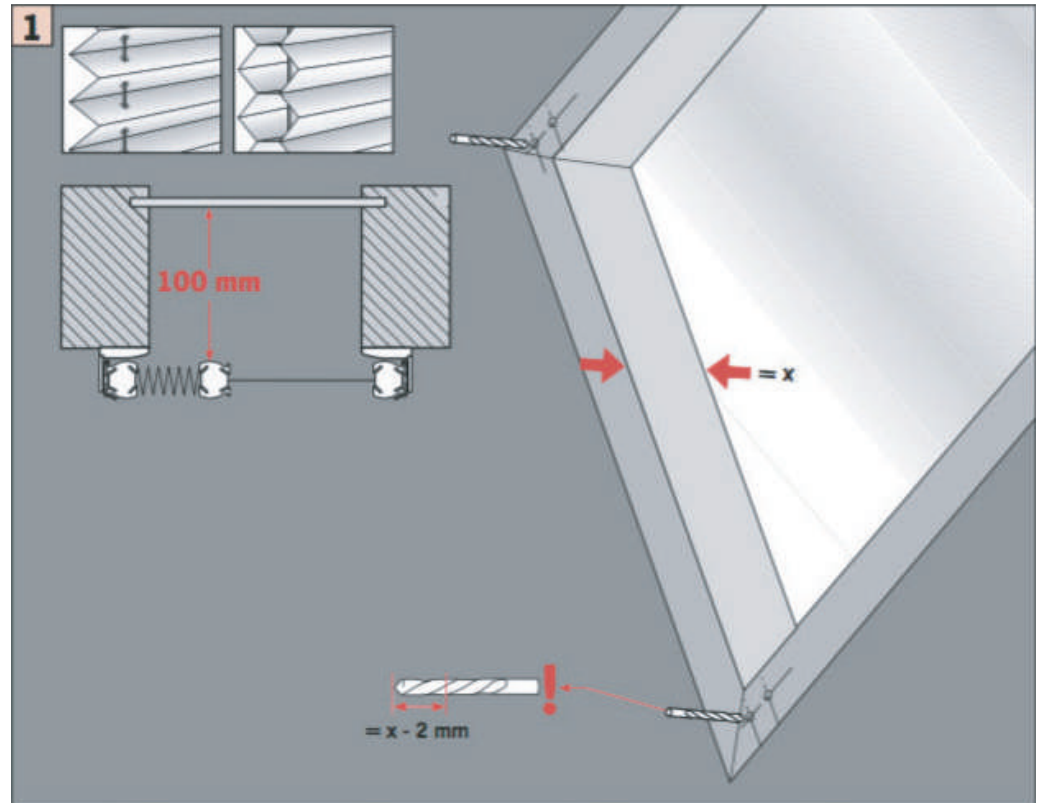
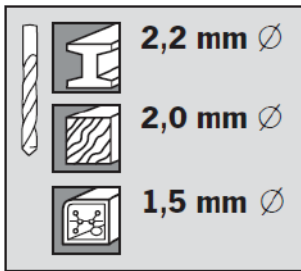
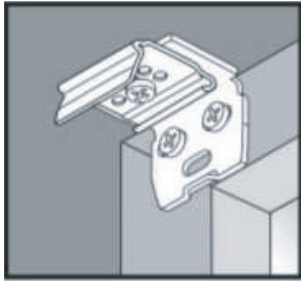

DEMONTAŽA

Disassembly
Demontage